

**594980**

**PALLET TRUCK HEAVY DUTY 2.5 TONNE**

**511807**

**PALLET TRUCK SUPER LOW PROFILE**

**1 TONNE**

**TOOLEX<sup>®</sup>**  
**Industrial**

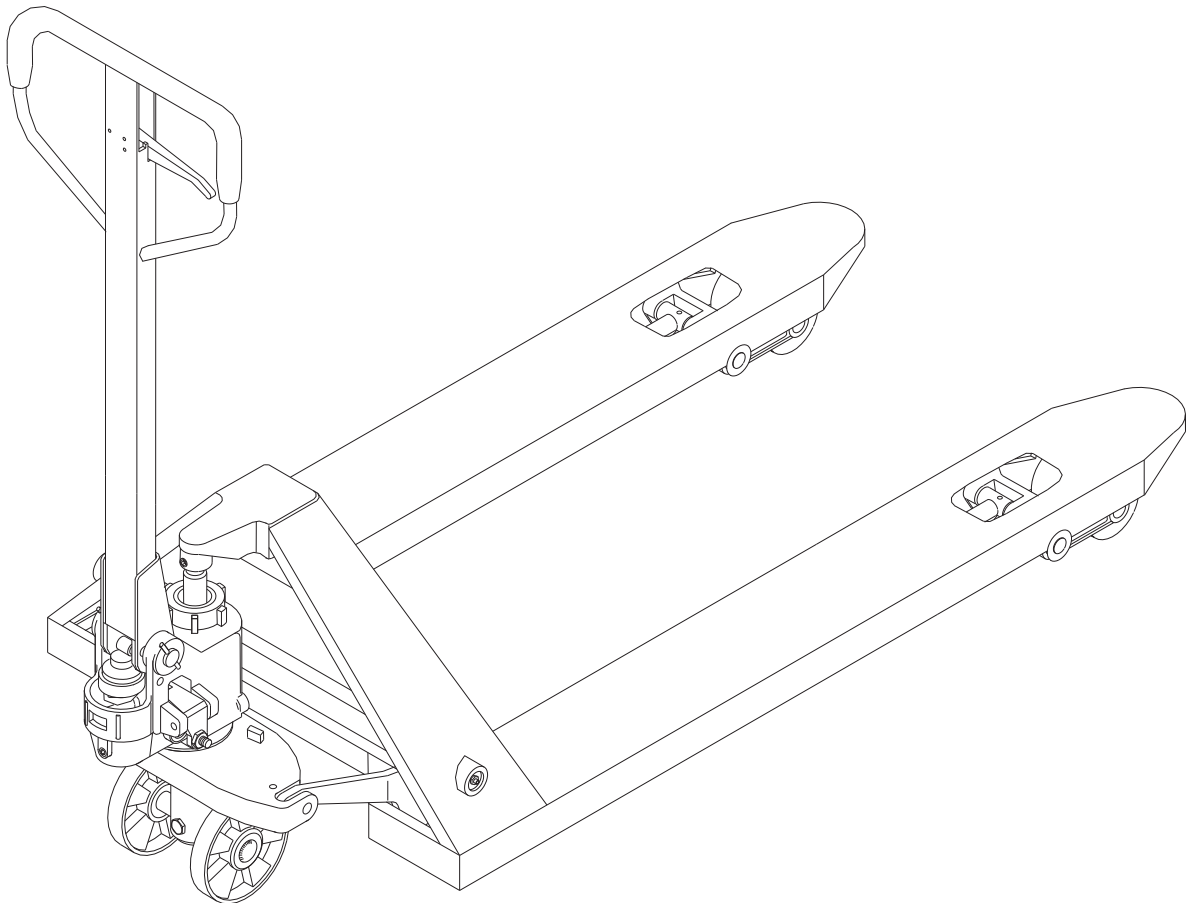

# **INSTRUCTION MANUAL**

CONSUMER SERVICE CENTRE  
PO BOX 1012  
HAMILTON NSW 2303 AUSTRALIA  
Made in P.R.C.



## **EC Declaration of Conformity**

According to the Machinery Directive 2006/42/EC



For the following equipment:

Product : Hand Pallet Truck  
Type Designation / Trademark : 594980  
Manufacturers Name : Toolex Industrial  
Manufacturers Address : PO Box 1012 Hamilton NSW 2303 Australia

Refer to in this declaration conforms to the following directive(s):

### **Machinery Directive 2006/42/EC**

The company named above will keep on file for review the following technical documentation:

- Operating and maintenance instructions
- Technical drawings
- Risk assessment
- Description of measures designed to ensure conformity
- Other technical documentation, e.g. quality assurance measures for design and production

## Note:

1. The truck shall be used, serviced and repaired according to the manufacturer's requirements.
2. The truck shall not be modified or have attachments fitted without ensuring that the truck is still safe.
3. When the cargo weight exceeds 2500kg, please operate the truck by two persons together for labor-saving.

## 1 . Applicable Range

- 1.1 Hand pallet truck is a low lift transportation tool which is limited to move palletized cargo. This kind of truck possesses the feature of stable lifting, easy operation, safety and reliability etc.
- 1.2 The working place must be non-slip, hard and flat ground without holes or obstacles.
- 1.3 The ambient lighting is 50 lux at least.

## 2 . Main parameter

Capacity	( Kg )	2000/2500/3000
Max. lift height	(mm)	200/190
Lowered fork height	(mm)	85/75
Height of handle	(mm)	431.5/421.5
Fork length	(mm)	600/650/700/750/800/850/900/950 /1000/1050/1100/1150/1220
Width over the forks	(mm)	520/550/685
Steering wheel diameter	(mm)	Φ200/180
Fork wheel diameter	(mm)	Φ80/74
Noise Lever	(dB)	<70
Service weight	(Kg)	52~74

## 3 . Assembly of hand pallet truck

3.1 See fig 1, pull out the pin roll 1.

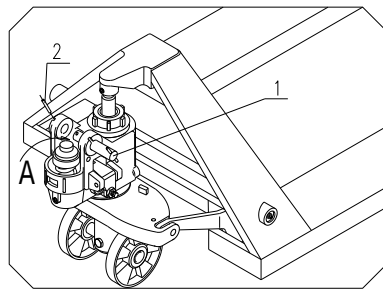

Fig. 1

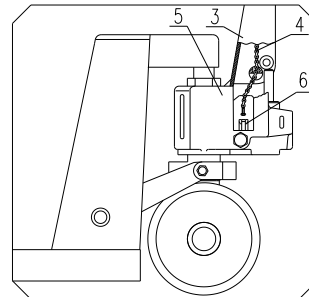

Fig. 2

3.2 Insert the hand grip 3 to place A. Couple the hand grip 3 and pump body 5 with pin roll 1.

3.3 Then get the spring pin 2 through pin roll 1 and fix it.

3.4 See fig 2. Put the chain 4 of hand grip get across the middle hole of pin roll 1.

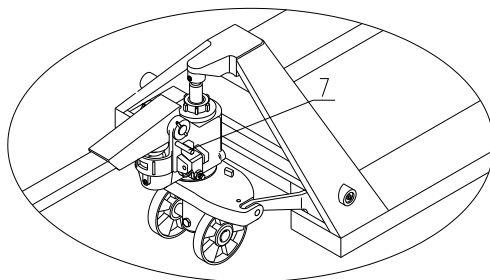

Fig. 3

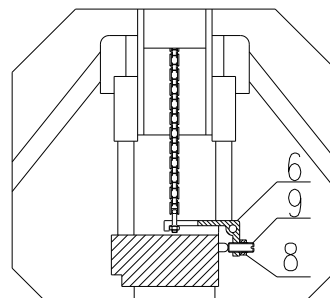

Fig. 4

3.5 Take screw nut which is at the end of chain 4 and hitch the groove of lever board 6. See fig 2 and fig 4.

3.6 See fig 3, turn the hand grip to the level position, pull out pin 7 and save pin 7 with care for next use.

## 4. Test of hand pallet truck

4.1 After the truck is assembled, try to rock the hand grip and operate different positions of control handle knob 10 to examine the lifting, free position and dropping and check that whether the different positions are normal or not. See fig 5.

4.2 The screw 9 in fig 4 is used to adjust the truck situation. When the truck body drops immediately after it is lifted, you should turn the screw 9 a

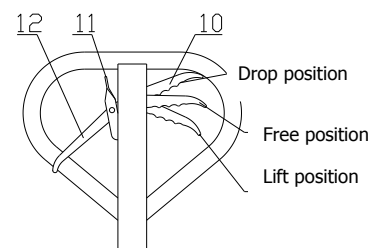

Fig. 5

little counter-clockwise. And then try the truck again until truck body could lift normally. If the truck body couldn't drop after it is lifted, you should turn the screw 9 a little clockwise. And then try to operate truck again until the truck body could drop normally. The external hexagon nut 8 at screw 9 Plays the locking function in the truck. So you should undo the external hexagon nut 10 before adjustment. And screw down the nut 8 after you finish the adjustment.

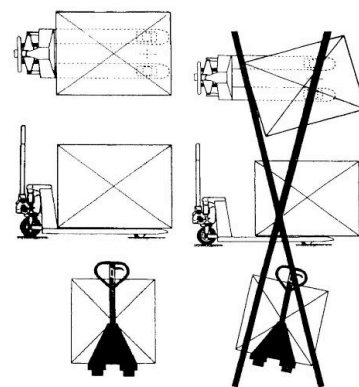

Fig. 6

## 5. Operation Manual

5.1 Before operation of the hand pallet truck please make sure that whether the cargo weight exceeds the rated load or not.

5.2 The cargo loading type is shown as fig 6.

5.3 See fig 5, when hand knob 10 is placed on the lift position, the truck will be in a state of lift. At this time, if you rock the hand grip, the truck will be lifted.

5.4 See fig 5, when hand knob 10 is placed on the free position, the truck will travel. At this time, if you rock the hand grip, the truck will neither lift nor drop. Then, you can use the truck to move the cargo.

5.5 See fig 5, when the hand knob 10 is placed on

The drop position, truck forks will drop. At this time, the truck forks will drop automatically.

5.6 See fig 5, when the hand knob 12 is placed below, the truck will be in a state of free walking.

5.7 See fig 5, when the hand knob 12 is placed above, the truck will be in a state of brake.

5.8 See fig 5, hand knob 11 is used for release brake.

## 6. Points for attention and safety norms.

6.1 The operators must put on the work clothes, safety shoes and gloves during the operation of the hand pallet truck.

6.2 When the hand pallet trucks are transported by truck, the hand pallet trucks should be locked in order to prevent the trucks from moving.

6.4 When the hand pallet truck is used for the motor vehicle, the truck must be moved slowly to ensure safety.

6.5 The wheels, bearings and bushings of the truck are wearing parts. Please change them according to situation.

6.6 Do not park the truck on the slope or in emergency passages.

6.7 When the hand pallet truck is used on the slope, the operator should operate the pallet truck carefully to ensure the operator on top of the slope.

6.8 When the hand pallet truck is not in use, the forks should be lowered to the lowest position.

6.9 It is forbidden to stop the truck on the slope.

6.10 Do not park the truck at places where will block the traffic or is inconvenient for work.

6.11 Do not use the truck in rainy environment.

6.12 It is forbidden for the operator to sit or stand on the hand pallet truck to operate the truck.

6.13 It is forbidden to make turns on the slope.

6.14 Do not pile the cargo too high in order to prevent the goods from falling down or overturning of the truck.

6.15 Do not use the hand pallet truck to carry people.

6.16 Untrained personnel are not allowed to stand around the operation area in order to avoid injury caused by sudden malfunction.

6.17 Before the hand pallet truck is pushed into the elevator, the operator shall make sure that the elevator can bear the total load of hand pallet truck and cargo as well as the total weight of the operator and other personnel in the elevator. When entering the elevator, people should let the load enter first but not operator. When the load or hand pallet truck enters or leaves the elevator, other personnel should not stay in the elevator.

6.18 The hand pallet truck should be stored in dry and ventilated environment.

6.19 When the cargo weight exceeds 2500kg, please operate the truck by two person together for labor-saving.

## 7. Inspection before use

If the hand pallet truck is not used for a long time, air may get into the hydraulic system. Due to this, the trouble can be eliminated by the following method:

Turn the hand knob to the drop position and rock the handle for 4 to 6 times. Then release the operation knob. If necessary, the process can be repeated for several times until the hand pallet truck can be operated normally.

## 8. Loading type and rated weight

The ideal loading type is that the gravity center of the cargo is just in the middle of the truck forks. The rated weight must be reduced when the cargo gravity center is not in the middle of the truck forks. The rated weight is shown as the label.

## 9. Oil

The oil capacity which oil pump needs is about 250ml (or 0.25kg). According to the ISO oil criterion, the choice of oil is 32# when the environment temperature during -5~40℃. The choice of oil is low temperature oil when the environment temperature during -35~-5℃.

## 10. Maintenance and upkeep

The routine check should be carried out daily and every abnormal phenomenon should be dealt with immediately. Please do not use faulty truck in order to prolong the service life. If there are any faults, please consult the professional. If it is necessary to replace the parts, the new parts should be provided by the original manufacturer. All the rotary joints should renew the motor oil every three months. Especially pay more attention to the place between wheel and axis. Make sure that there is not any yarn or other rags in order to keep all wheels running with handiness. After the maintenance and upkeep, please record in the list below:

### Maintenance and upkeep recording list

Starting date of using:

Maintenance date	Faults	Parts replace	Sign

## 11. Possible faults and trouble shooting

No.	Faults	Causes	Trouble shooting
1	The forks can't be lifted to the maximum lift height	Hydraulic oil is not enough.	Add appropriate filtrated working oil.
2	The forks can't return to the lowest position.	1. Too much hydraulic oil. 2. The rotary parts are deformed Or blocked. 3. The trunk piston and guides bushing are blocked.	1. Take out appropriate working oil 2. Replace the parts.
3	The forks can't drop after lifted.	1. There is something abnormal in the unloading device. 2. The parts are deformed and damaged.	1. Readjust the unloading device, see item 4.2. 2. Replace the deformed and damaged parts.
4	Hydraulic oil leakage	1. The oil seal is unavailable. 2. The surface of some parts is damaged or worn. 3. The coupled places become loosened.	1. Replace the oil seal. 2. Replace the damaged parts. 3. Fasten the loosened place again.
5	The fork can't be lifted.	1. The viscosity of the working oil is too high, or there is no working oil. 2. There is impurity in the oil. 3. There is something abnormal in the unloading device.	1. Replace the working oil. 2. Clear up the impurity and add new working oil 3. Readjust the unloading device, see item 4.2.
6	When the handle is rocked, the forks drop immediately after they are lifted; the handle returns or the forks drop markedly after they are lifted.	The valve of oil pump is blocked by abnormal matter.	Open the valve and take out the parts. Then re-install the parts after they are cleaned.

## 12 . Disposal of waste oil

The waste hydraulic oil shall be disposed in terms of relative laws. And it is forbidden to pouring out anywhere.

## 13 . Warning level

- 13.1 Please read the operation instruction carefully before you operate the hand pallet truck and learn about all the features of this type of hand pallet truck.
- 13.2 If you want to let the truck down by controlling the hand knob, you should better lift the hand knob a little at first, and then let the truck down slowly. It is forbidden to pull the handle knob with great force, because rapid dropping could cause some damages to both the hand pallet truck and cargo.
- 13.3 Don't rock the hand grip at a high speed and in a high frequency!
- 13.4 Don't load the cargo at a high speed !
- 13.5 Do not overload the forks. Overloading could keep the hand pallet truck from working normally.
- 13.6 The gravity center of cargo should be in the middle of truck forks. The offset of cargo could make hand pallet truck out of balance !
- 13.7 Don't load loose or unstable goods!
- 13.8 Don't put the goods on the truck fork for a long time!
- 13.9 When the truck does not work, make sure that the truck forks are on the lowest position and the power should be cut off!
- 13.10 It is forbidden to load people and let them stand on the forks to slide. Don't put any part of body below the cargo.
- 13.11 Do not operate the unnamed position!
- 13.12 The truck shall be used, serviced and repaired according to the manufacturer's requirements and shall not be modified or have attachments fitted without ensuring that the truck is still safe.
- 13.13 Do not use the hand pallet truck at an insufficiently illuminated place!
- 13.14 Do not park the hand pallet truck by turning the hand grip to the right!
- 13.15 Do not use the hand pallet truck as bumper jack!
- 13.16 The extremity of fork arms shall not be used as a lever to lift a load!
- 13.17 It is forbidden to use the truck at places where a risk of unintentional movement exists.
- 13.18 It is forbidden to contact the truck with goods or cargo directly!
- 13.19 Do not use the hand pallet truck in a potentially explosive atmosphere !
- 13.20 During the operation of the hand pallet truck, the operator should pay more attention to the feet and any body part so as to avoid the risk of being crushed.
- 13.21 The truck shall be used, serviced and repaired according to the manufacturer's requirements.