

532217

PARTS BREAKDOWN

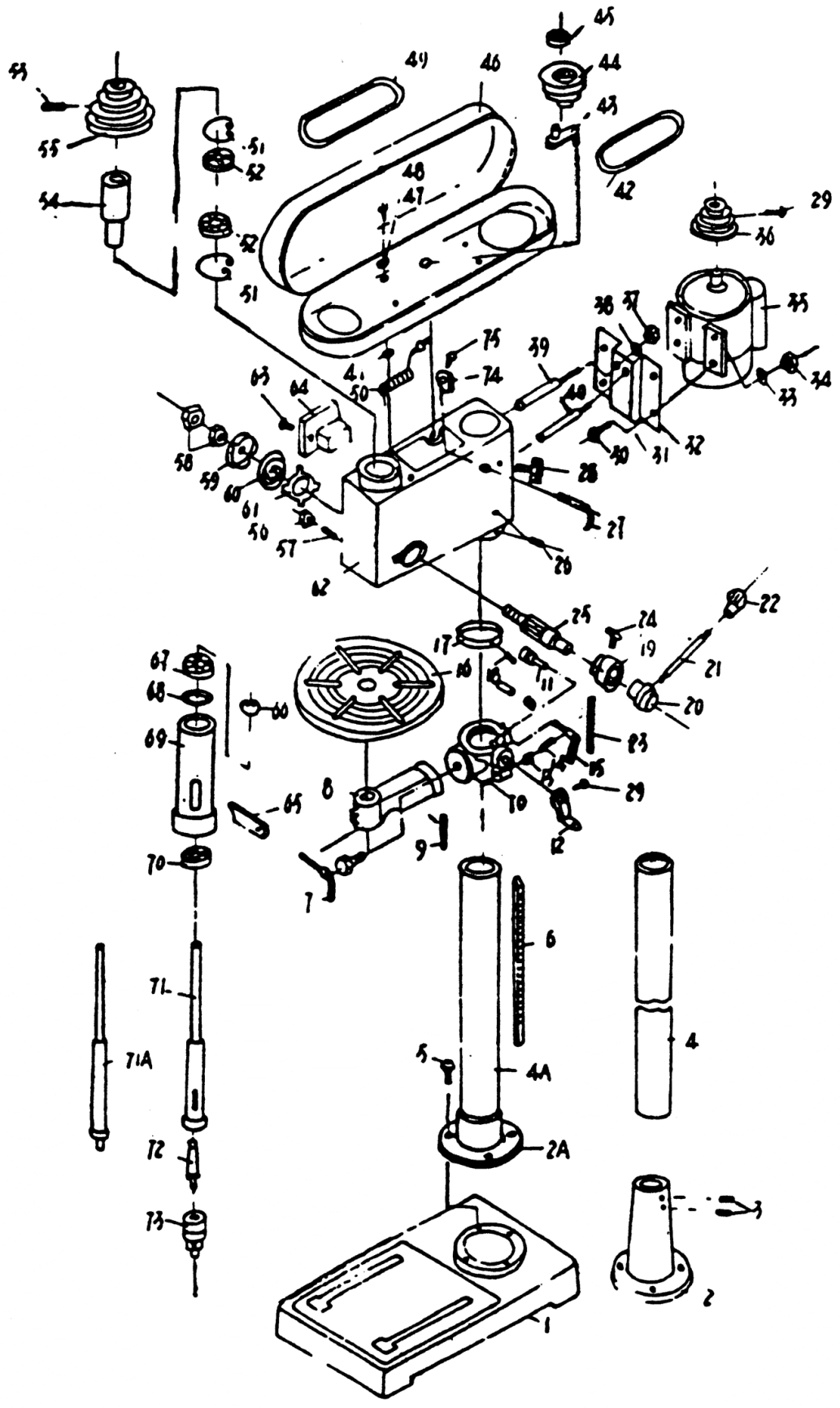

PART NO.	NAME	PART NO.	NAME
1	Base	38	Shaft
2	Flanged column base	40	Adjusting shaft
3	Fixing screw	41	Rubber ring
4	Column	42	V-Belt
5	Bolt	43	Pulley spindle
6	Teeth	44	Pulley
7	Table lock handle	45	Bearing
8	Table bracket	46	Pulley cover
9	Angle scale	47	Washer
10	Working table holder	48	Bolt
11	Worn pinion	49	V-belt
12	Handle	50	Electric
13	Gear	51	C-spring
14	Pin	52	Bearing
15	Locking handle	53	Nut
16	Working table	54	Keyway spindle
17	Ring	55	Spindle pulley
18	Bolt	56	Nut
19	Depth indicator	57	Fixing screw
20	Handle seat	58	Nut
21	Handle	59	Spring cover
22	Handle tip	60	Spring
23	Depth scale	61	Spring seat
24	Fixing screw	62	Houseing
25	Feeding shaft	63	Firing screw
26	Fixing screw	64	Switch
27	Adjusting handle	65	Wedge
28	Fixing bolt	66	C-spring
29	Fixing screw	67	Bearing
30	Bolt	68	Rubber ring
31	Washer	69	Spindle socket
32	Motor fixing plate	70	Bearing
33	Washer	71	Spindle
34	Nut	72	Tapped spindle tip
35	Motor	73	Chuck
36	Motor pulley	74	Adjusting block
37	Nut	75	Bolt
38	Washer	76	Switch seat